

Dual Common Source MOSFET Power Module

$V_{DSS} = 100V$
 $R_{DSon} = 2.25m\Omega$ typ @ $T_j = 25^\circ C$
 $I_D = 495A$ @ $T_c = 25^\circ C$

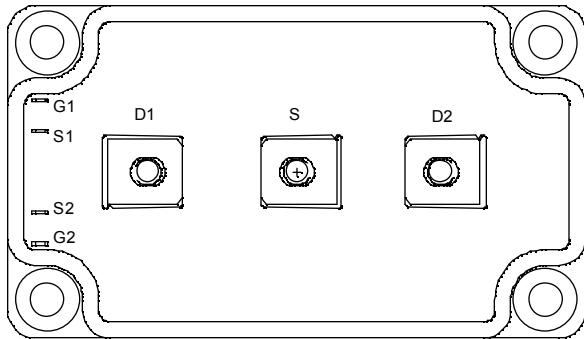
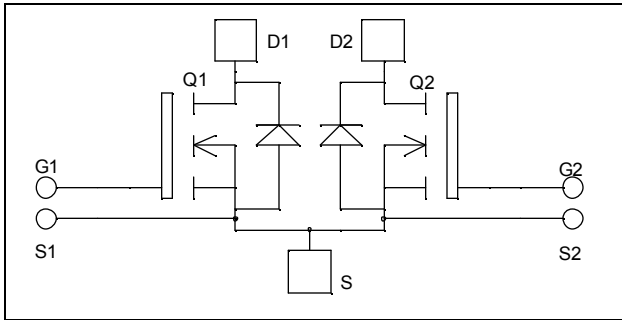

Application

- AC Switches
- Switched Mode Power Supplies
- Uninterruptible Power Supplies

Features

- Power MOS V[®] MOSFETs
 - Low R_{DSon}
 - Low input and Miller capacitance
 - Low gate charge
 - Avalanche energy rated
 - Very rugged
- Kelvin source for easy drive
- Very low stray inductance
 - Symmetrical design
 - M5 power connectors
- High level of integration

Benefits

- Outstanding performance at high frequency operation
- Direct mounting to heatsink (isolated package)
- Low junction to case thermal resistance
- Low profile
- RoHS Compliant

Absolute maximum ratings

Symbol	Parameter	Max ratings	Unit
V_{DSS}	Drain - Source Breakdown Voltage	100	V
I_D	Continuous Drain Current	$T_c = 25^\circ C$	495
		$T_c = 80^\circ C$	370
I_{DM}	Pulsed Drain current	1900	
V_{GS}	Gate - Source Voltage	± 30	V
R_{DSon}	Drain - Source ON Resistance	2.5	$m\Omega$
P_D	Maximum Power Dissipation	$T_c = 25^\circ C$	1250
I_{AR}	Avalanche current (repetitive and non repetitive)	100	A
E_{AR}	Repetitive Avalanche Energy	50	mJ
E_{AS}	Single Pulse Avalanche Energy	3000	

CAUTION: These Devices are sensitive to Electrostatic Discharge. Proper Handling Procedures Should Be Followed. See application note APT0502 on www.microsemi.com

All ratings @ $T_j = 25^\circ\text{C}$ unless otherwise specified

Electrical Characteristics

Symbol	Characteristic	Test Conditions	Min	Typ	Max	Unit
I_{DSS}	Zero Gate Voltage Drain Current	$V_{GS} = 0V, V_{DS} = 100V$			400	μA
		$V_{GS} = 0V, V_{DS} = 80V$			2000	
$R_{DS(on)}$	Drain – Source on Resistance	$V_{GS} = 10V, I_D = 200A$		2.25	2.5	$\text{m}\Omega$
$V_{GS(th)}$	Gate Threshold Voltage	$V_{GS} = V_{DS}, I_D = 10\text{mA}$	2		4	V
I_{GSS}	Gate – Source Leakage Current	$V_{GS} = \pm 30V, V_{DS} = 0V$			± 400	nA

Dynamic Characteristics

Symbol	Characteristic	Test Conditions	Min	Typ	Max	Unit
C_{iss}	Input Capacitance	$V_{GS} = 0V$		40		nF
C_{oss}	Output Capacitance	$V_{DS} = 25V$		15.7		
C_{rss}	Reverse Transfer Capacitance	$f = 1\text{MHz}$		5.9		
Q_g	Total gate Charge	$V_{GS} = 10V$ $V_{Bus} = 50V$ $I_D = 400A$		1360		nC
Q_{gs}	Gate – Source Charge			240		
Q_{gd}	Gate – Drain Charge			720		
$T_{d(on)}$	Turn-on Delay Time	Inductive switching @ 125°C $V_{GS} = 15V$ $V_{Bus} = 66V$ $I_D = 400A$ $R_G = 1.25\Omega$		160		ns
T_r	Rise Time			240		
$T_{d(off)}$	Turn-off Delay Time			500		
T_f	Fall Time			160		
E_{on}	Turn-on Switching Energy	Inductive switching @ 25°C $V_{GS} = 15V, V_{Bus} = 66V$ $I_D = 400A, R_G = 1.25\Omega$		2.2		mJ
E_{off}	Turn-off Switching Energy			2.41		
E_{on}	Turn-on Switching Energy	Inductive switching @ 125°C $V_{GS} = 15V, V_{Bus} = 66V$ $I_D = 400A, R_G = 1.25\Omega$		2.43		mJ
E_{off}	Turn-off Switching Energy			2.56		

Source - Drain diode ratings and characteristics

Symbol	Characteristic	Test Conditions	Min	Typ	Max	Unit
I_S	Continuous Source current (Body diode)		$T_c = 25^\circ\text{C}$		495	A
			$T_c = 80^\circ\text{C}$		370	
V_{SD}	Diode Forward Voltage	$V_{GS} = 0V, I_S = -400A$			1.3	V
dv/dt	Peak Diode Recovery ❶				5	V/ns
t_{rr}	Reverse Recovery Time	$I_S = -400A$ $V_R = 66V$	$T_j = 25^\circ\text{C}$		270	ns
Q_{rr}	Reverse Recovery Charge	$di_s/dt = 400A/\mu\text{s}$	$T_j = 25^\circ\text{C}$		11.6	μC

 ❶ dv/dt numbers reflect the limitations of the circuit rather than the device itself.

$$I_S \leq -495A \quad di/dt \leq 400A/\mu\text{s} \quad V_R \leq V_{DSS} \quad T_j \leq 150^\circ\text{C}$$

Thermal and package characteristics

Symbol Characteristic

		<i>Min</i>	<i>Typ</i>	<i>Max</i>	<i>Unit</i>	
R_{thJC}	Junction to Case Thermal Resistance			0.1	°C/W	
V_{ISOL}	RMS Isolation Voltage, any terminal to case t =1 min, I Isol<1mA, 50/60Hz	2500			V	
T_J	Operating junction temperature range	-40		150	°C	
T_{STG}	Storage Temperature Range	-40		125		
T_C	Operating Case Temperature	-40		100		
Torque	Mounting torque	To heatsink	M6	3	5	N.m
		For terminals	M5	2	3.5	
Wt	Package Weight			280	g	

SP6 Package outline (dimensions in mm)

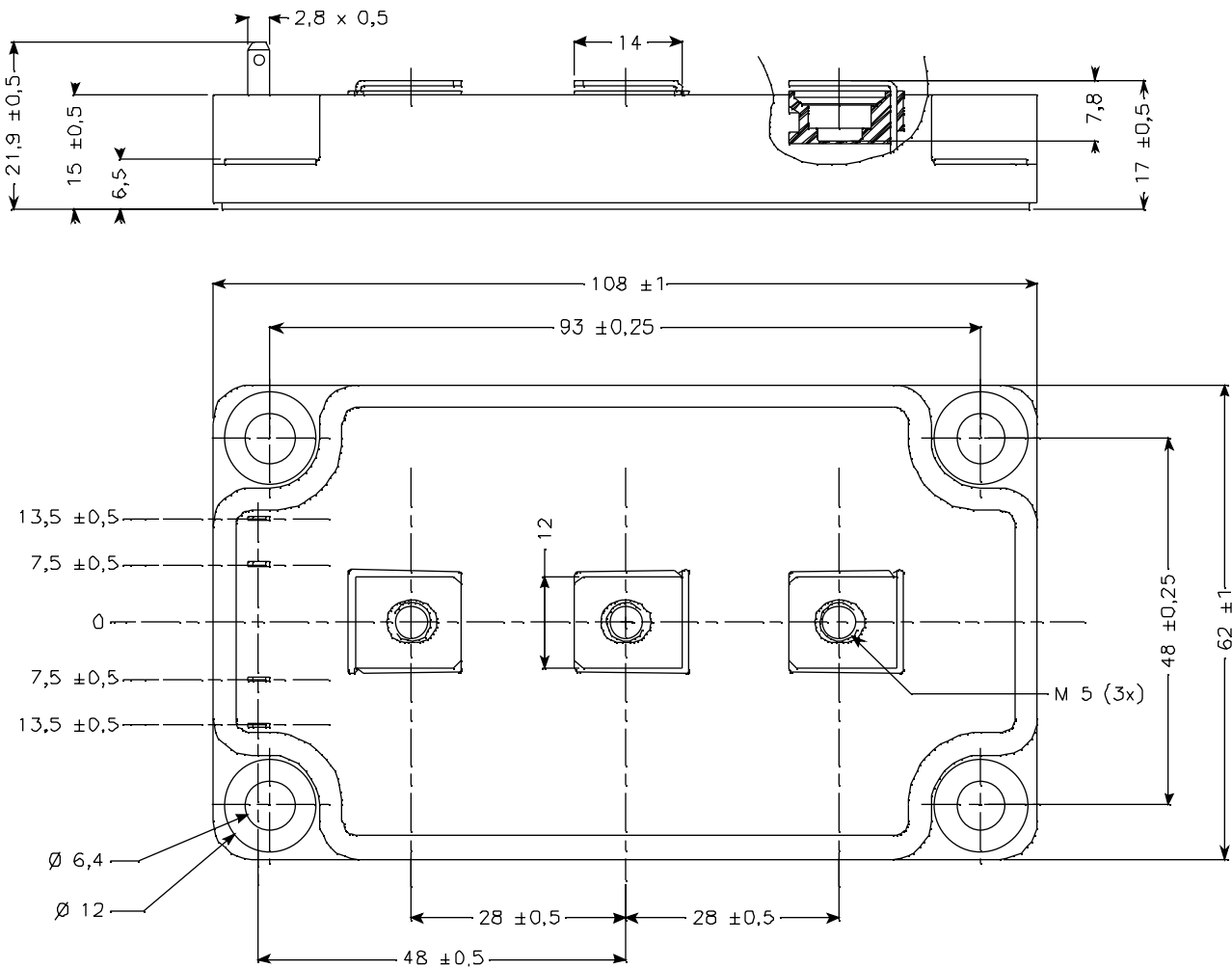

See application note APT0601 - Mounting Instructions for SP6 Power Modules on www.microsemi.com

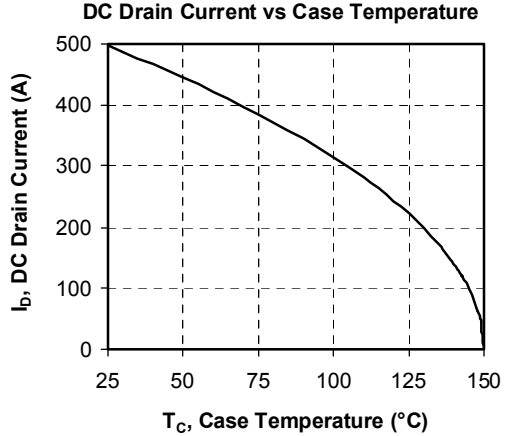
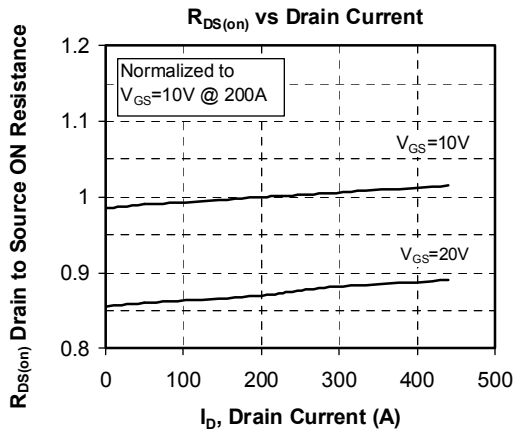
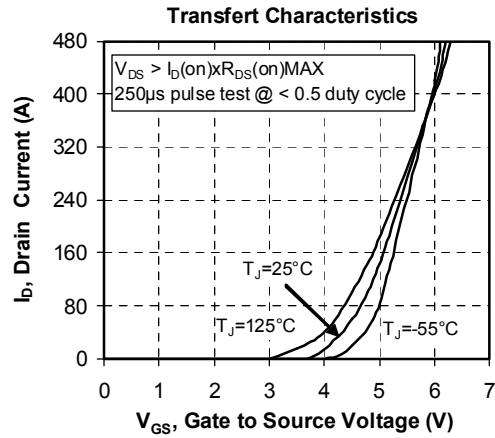
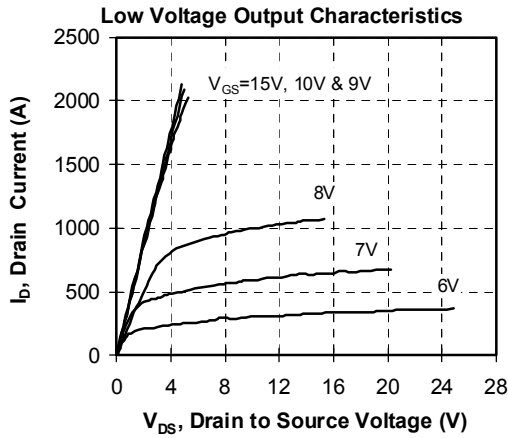
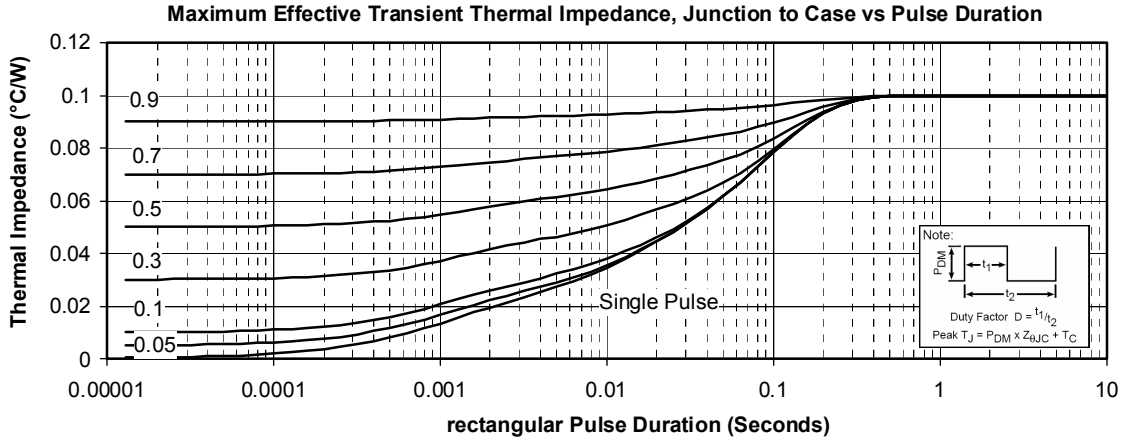
Typical Performance Curve

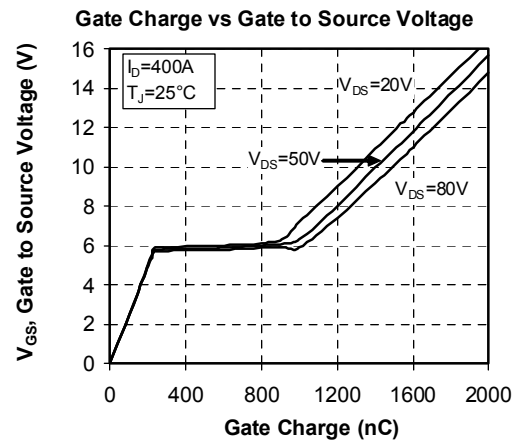
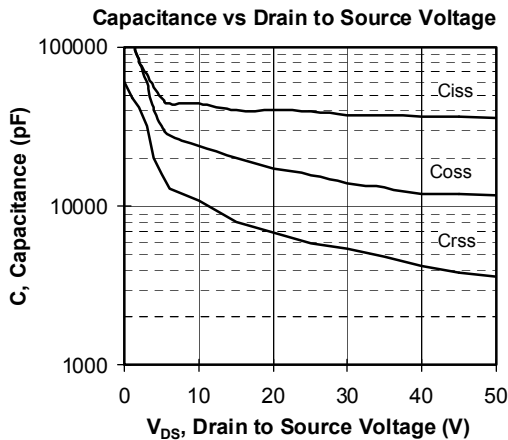
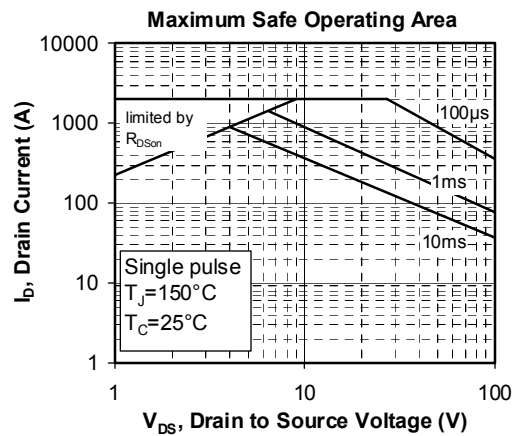
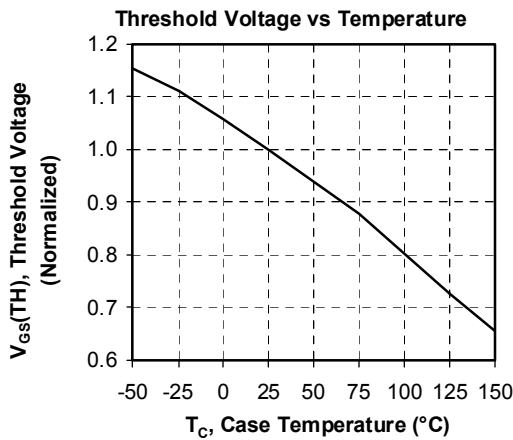
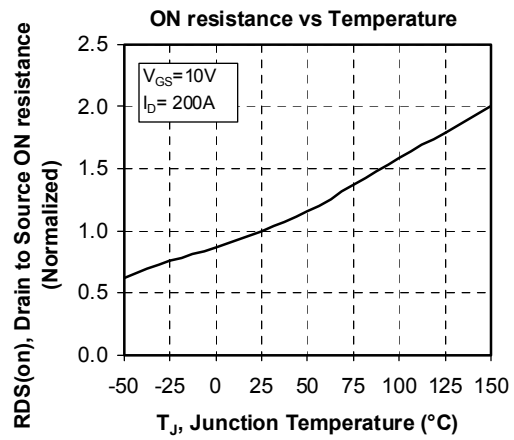

Delay Times vs Current

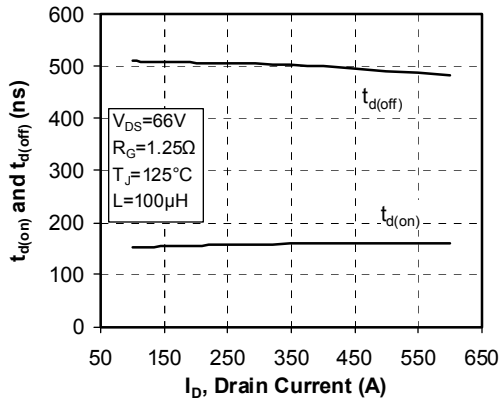

Rise and Fall times vs Current

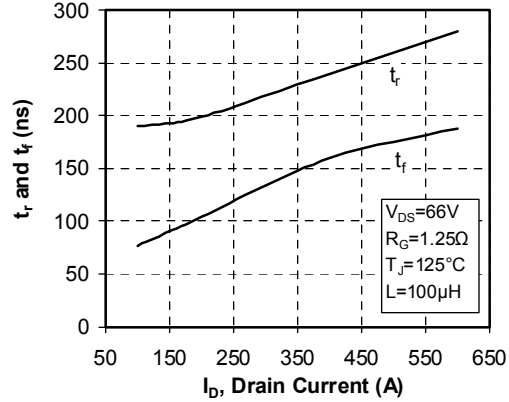

Switching Energy vs Current

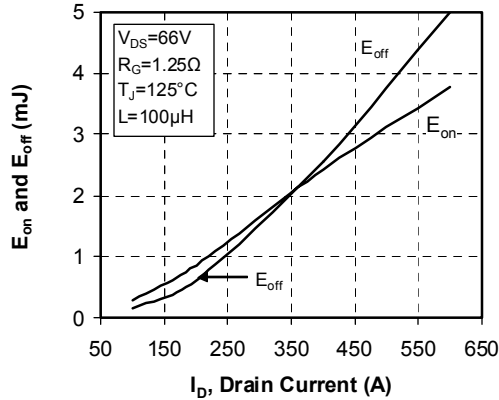

Switching Energy vs Gate Resistance

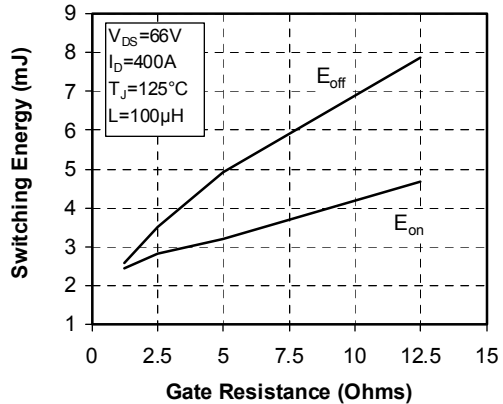

Operating Frequency vs Drain Current

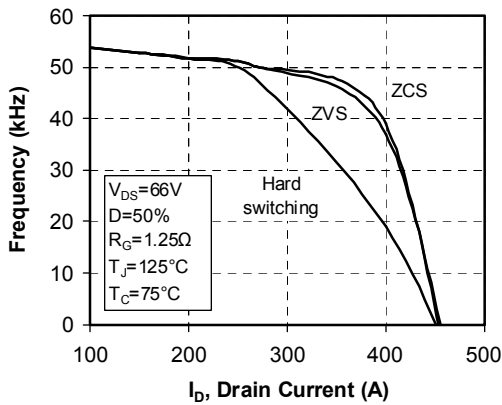

Source to Drain Diode Forward Voltage

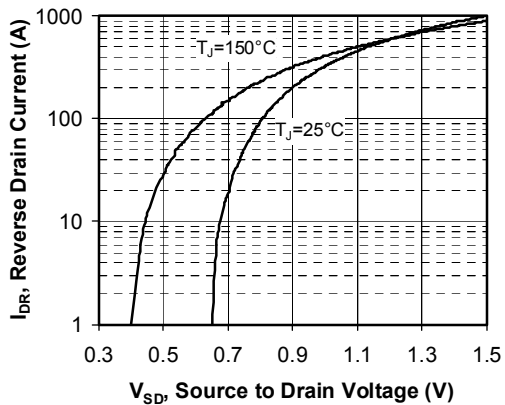

Microsemi reserves the right to change, without notice, the specifications and information contained herein

Microsemi's products are covered by one or more of U.S. patents 4,895,810 5,045,903 5,089,434 5,182,234 5,019,522 5,262,336 6,503,786 5,256,583 4,748,103 5,283,202 5,231,474 5,434,095 5,528,058 and foreign patents. U.S. and Foreign patents pending. All Rights Reserved.